

# Metal catalog 2021

Metal profiles

**Döllken**  
Profiles

we create.  
we innovate.

SURTECO GROUP

# Profiles that connect



The metal profiles from Döllken Profiles combine high-quality materials with optimal installation options.

Regardless of whether it is a perfect finish, height compensation or transition to adjacent floor coverings, our range offers optimal edge protection for a wide variety of floor coverings, even for rooms with underfloor heating or designer coverings. The profiles are also suitable for barrier-free, age- and handicapped-friendly living spaces.



# Installed quickly and easily

				
Work steps (in min)	Standard self-adhesive	Standard with screws and dowels	Standard with dowels without screws	Premium / clip profiles
1) Work steps determine	5	5	5	10
2) Measure and Cutting to length	5	5	5	10
3) Mark the Drill holes		2	2	2
4) drilling		4	4	4
5) Insert dowels		2	2	2
6) Attach Unterprofil with Screws				5
Alternatively: lower profile with assembly / contact adhesive (Waiting time drying out)				5 [24 hours]
7) Attaching top profile (Waiting time glue)	3 [10 min]	5	5	
<b>Minutes total</b>	 <b>13</b>	 <b>23</b>	 <b>23</b>	 <b>38</b>

## Our customer service for you

The direct line to us:

**Wholesale & specialist market**  
+49 3643 4170 711  
info@doellken-profiles.com

**DIY store**  
+49 2383 910 00 717  
kundencenter@praktikus.de

For inquiries outside of our opening times, you can also contact us via chat (available via the Döllken app).

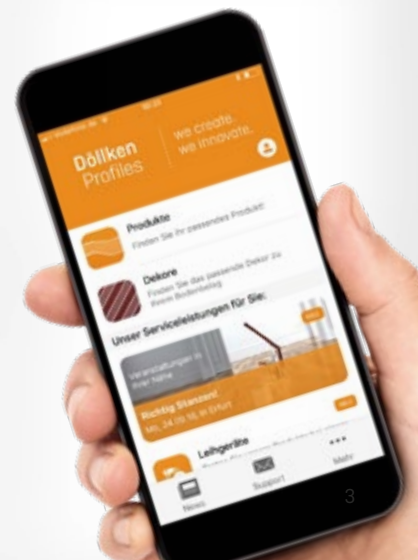

**i**

Dear customers and interested parties,  
Please note that this catalog now contains  
the entire metal range from Praktikus.

**Praktikus**  
A SURTECO BRAND

# Table of Contents

pages



## Self-adhesive Profiles

5-8

For smooth surfaces and rooms with underfloor heating



## Universal profiles

9-16

Robust and hard-wearing profiles



## Clip profiles

17-21

Robust and hard-wearing profiles

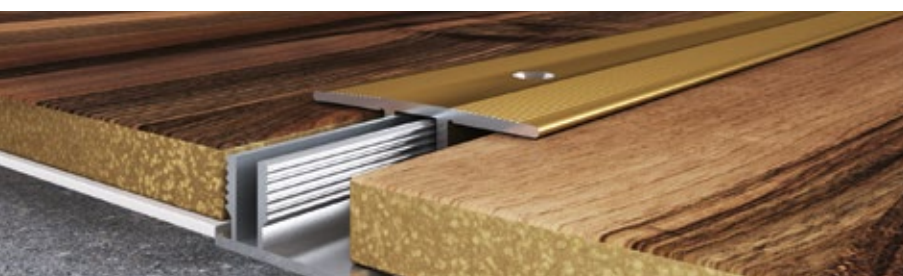

## Professional rails

22-24

Reliable profiles on a wide variety of floor coverings

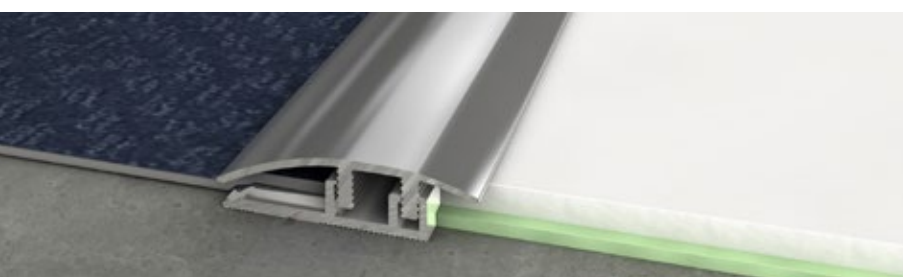

## Expert design Profiles

25-27

Especially for design coverings



## Plastic profiles

28-30

Flexible profiles made of high quality plastic

# Self-adhesive Profiles



Processed in just 13 minutes

## Convincing in practical use

The SK profiles are characterized by the following properties and advantages:

- Self-adhesive - no drill required
- No visible screws
- Very robust and durable
- Quick and easy assembly
- Particularly suitable for smooth surfaces and rooms with underfloor heating

### Overview of the SK profiles

Page

Transition profiles standard SK .....	6
Transition profiles 2 grooves SK .....	7
End profiles SK .....	7
Compensation profiles SK .....	8
Edging profile SK .....	8



Please note that the decor images and colors do not always correspond one hundred percent to the real decor and that there may be color deviations. If you would like to have a binding decor in advance, simply request a sample via our hotline +49 2383 910 00 717 (contact person for DIY stores) or +49 3643 4170 711 (contact person for wholesalers)!

# Transition profile standard SK



## Suitable for the following types of flooring

- Particularly suitable for smooth coverings and for rooms with underfloor heating

## Product Information



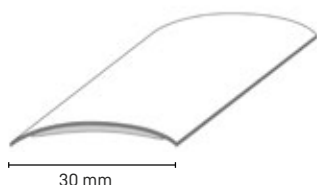

- Sturdy, anodized aluminum, wood decors are additionally coated with foil
- Self adhering
- SB-packed with assembly instructions

Available in the following dimensions:



- 1 unit = 10 x 100 cm
- 1 unit = 5 x 250 cm

## Colours

			
	silver	messing	
100 cm	5103544	5103545	
250 cm	5105181	-	
			
	stainless steel	bronze	sand
100 cm	5105191	5103547	5111728
250 cm	5105183	-	5111181

## Installation recommendations

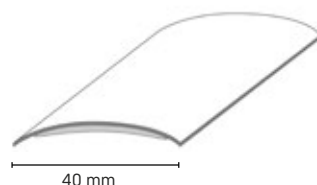

- 1 unit = 10 x 100 cm
- 1 unit = 5 x 250 cm

## Colours

			
	silver	messing	
100 cm	5105192	5105193	
250 cm	5105184	-	
			
	stainless steel	sand	
100 cm	5105194	5110854	
250 cm	5105186	5111732	

# Transition profiles

## 2 grooves SK



### Suitable for the following types of flooring

- Particularly suitable for smooth coverings and for rooms with underfloor heating

### Product Information

- Sturdy, anodized aluminum
- Self adhering
- SB-packed with assembly instructions

### Available in the following dimensions:

- 1 unit = 10 x 100 cm

### Installation recommendations

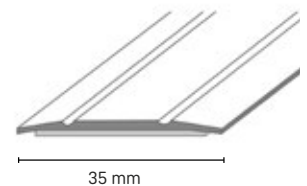

### Colours

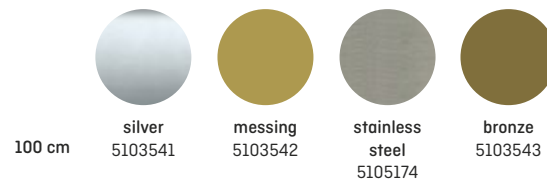

# End profiles SK



### Suitable for the following types of flooring

- Particularly suitable for smooth coverings and for rooms with underfloor heating

### Product Information

- Sturdy, anodized aluminum
- Self adhering
- SB-packed with assembly instructions

### Available in the following dimensions:

- 1 unit = 10 x 100 cm

### Installation recommendations

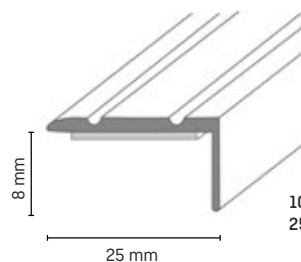

### Colours

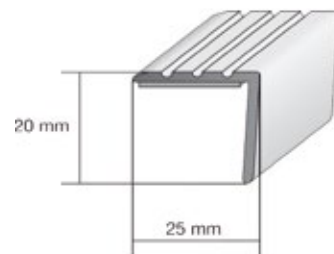

# Compensation profiles SK



## Suitable for the following types of flooring

- Particularly suitable for smooth coverings and for rooms with underfloor heating

## Product Information

- Sturdy, anodized aluminum
- Self adhering
- SB-packed with assembly instructions

## Available in the following dimensions:

- 1 unit = 10 x 100 cm
- 1 unit = 5 x 250 cm

## Installation recommendations

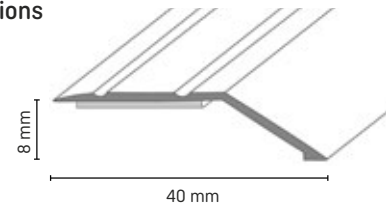

## Colours

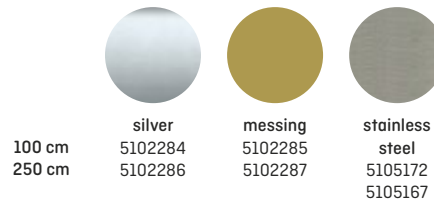

# Edging profile SK



## Suitable for the following types of flooring

- Particularly suitable for smooth coverings and for rooms with underfloor heating

## Product Information

- Sturdy, anodized aluminum
- Self adhering
- SB-packed with assembly instructions

## Available in the following dimensions:

- 1 unit = 10 x 100 cm

## Installation recommendations

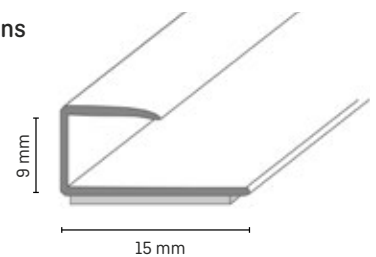

## Colours

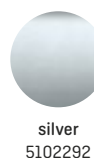



# Universal profiles



Processed in just 23 minutes

## Robust and lasting reliability

The universal profiles are characterized by the following properties and advantages:

- Sure-footed and impact-resistant
- Particularly resilient due to optimized material thickness
- Perfect finishes or transitions in no time at all
- Permanent stability thanks to the assembly with screws and dowels
- Optimal stepless adjustment of the profile in height and inclination by means of knock-in dowels
- Expansion joints can be closed at a later date

### Overview of the metal profiles

	Page
Transition profiles .....	10
Transition profiles 2 grooves .....	11
Stair angle .....	12
Carpet finishing profiles .....	13
Carpet edging profiles .....	13
Edging profiles .....	14
Parquet transition profile dowels .....	15
Dowel compensation profiles .....	16

# Transition profiles

Also as self-adhesive Variant available! (P. 7)

## Suitable for the following types of flooring

- Particularly suitable for carpeting or PVC, particularly suitable in entrance areas or corridors

## Product Information

- Particularly flat metal transition rail
- Permanent and inconspicuous protection of the transitions between carpeting or PVC from "lifting"
- Longevity and best color stability thanks to high-quality anodized aluminum
- Robust quality and easy assembly
- Perforated 100 cm variant including screws and dowels

## Installation recommendations



Screws and dowels

## Available in the following dimensions:

- 1 unit = 10 x 100 cm
- 1 unit = 5 x 250 cm

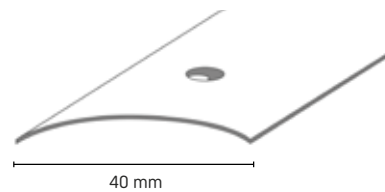
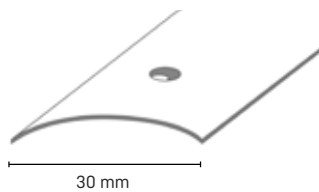

## Colours



## Colours

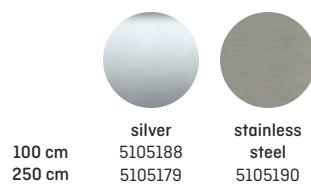

# Transition profiles 2 grooves

Also as  
**self-adhesive**  
Variant available!  
[P. 8]

## Suitable for the following types of flooring

- Particularly suitable for carpeting or PVC, particularly suitable in entrance areas or corridors





## Product Information

- Particularly flat metal transition rail
- Permanent and inconspicuous protection of the transitions between carpeting or PVC from "lifting"
- Longevity and best color stability thanks to high-quality anodized aluminum
- Robust quality and easy assembly
- Perforated 100 cm variant including screws and dowels

## Available in the following dimensions:

- 1 unit = 10 x 100 cm
- 1 unit = 5 x 250 cm

## Colours

				
100 cm	silver 5103575	messing 5103578	stainless steel 5105195	bronze 5103584
250 cm	5103587	-	-	-

## Installation recommendations



Screws and  
dowels

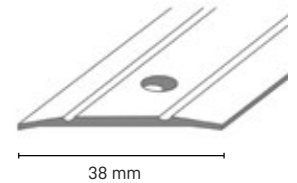

38 mm

# Stair angle

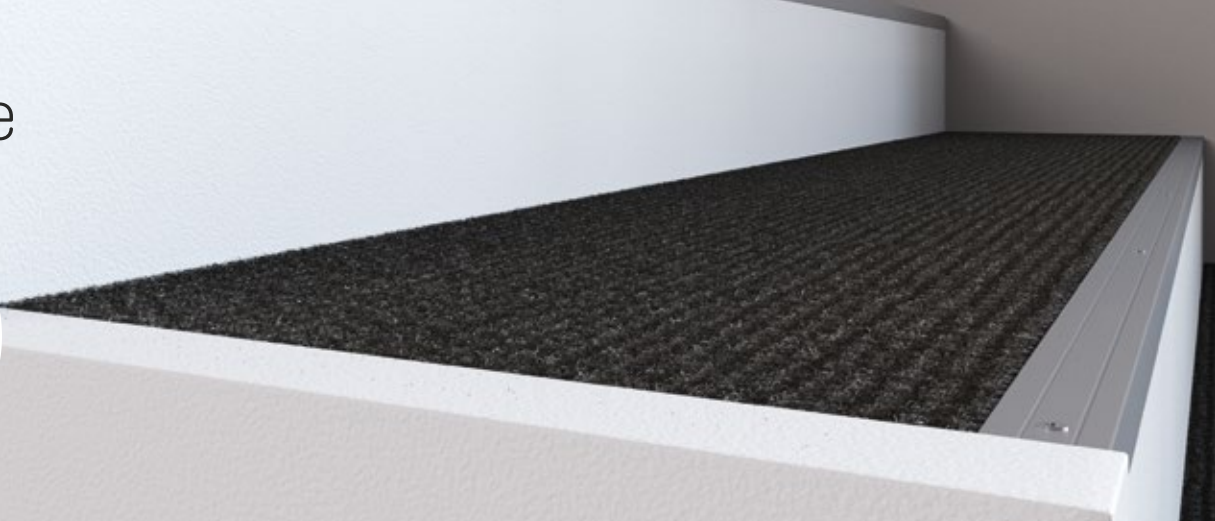

## Suitable for the following types of flooring

- All-rounder for stairs

## Product Information

- Robust stair angles made of anodized aluminum
- Long-term and reliable protection of the floor covering and the edges
- Hardened material that is almost indestructible, step and abrasion resistant and extremely color stable
- Grooves in the surface ensure a secure hold when climbing stairs
- Easy assembly with screws
- A fine hacksaw is suitable for cutting to length including screws and dowels

## Installation recommendations



Screws and dowels

## Available in the following dimensions:

- Width: 25 mm
- Height: 10mm
- 1 unit = 10 x 100 cm
- 1 unit = 5 x 250 cm

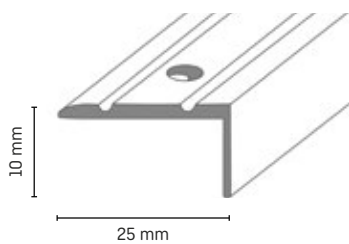

- Width: 25mm
- Height: 20mm
- 1 unit = 10 x 100 cm
- 1 unit = 5 x 250 cm

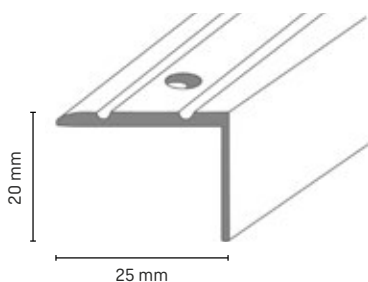

- Width: 45mm
- Height: 20mm
- 1 unit = 5 x 100 cm
- 1 unit = 5 x 250 cm

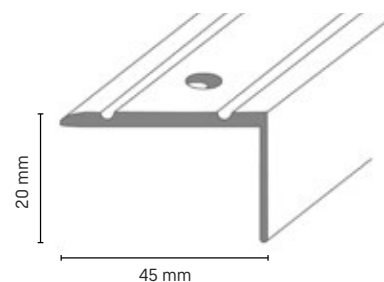

## Colours



	silver	messing	bronze
100 cm	5103603	5103606	5103609
250 cm	5120022	5103613	5103614

## Colours



	silver	messing	bronze
100 cm	5103591	5103594	5103597
250 cm	5120023	5103601	5120024

## Colours



	silver	messing	bronze
100 cm	5103409	5103412	5103415
250 cm	5103418	5103419	5103420

# Carpet finishing profiles



## Suitable for the following types of flooring

- Carpeting

## Product Information

- Made of abrasion-resistant and hard-wearing anodized aluminum
- Variable adaptation to different flooring heights up to 4 mm
- Conceivably simple assembly by screwing on with the supplied screws and dowels

## Available in the following dimensions:

- 1 unit = 10 x 100 cm

## Installation recommendation:



Screws and dowels

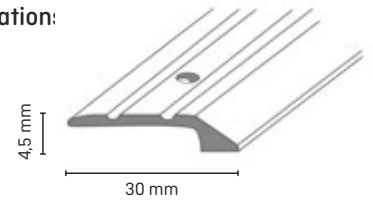

## Colours



silver  
5120030



messing  
5120031



bronze  
5103569

100 cm

# Edging profile



## Suitable for the following types of flooring

- Parquet and laminate

## Product Information

- Anodized aluminum profiles - non-slip and impact resistant
- With a visible profile width of 12 to 17 mm, they skilfully cover unclean cut edges
- Ensure perfect connections e.g. B. on other floor coverings
- The profiles are cut to length with a fine Hacksaw

## Installation recommendations

Metal-saw

Elongation  
note the joints

## Available in the following dimensions:

- 1 unit = 5 x 90 cm
- 1 unit = 5 x 270 cm

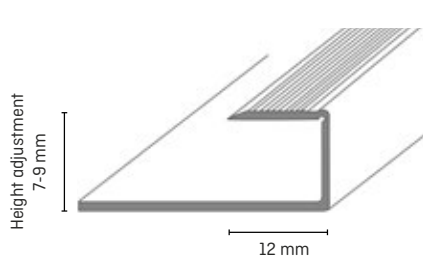

### Colours



	silver	messing
90 cm	5120032	5101911
270 cm	5101944	-

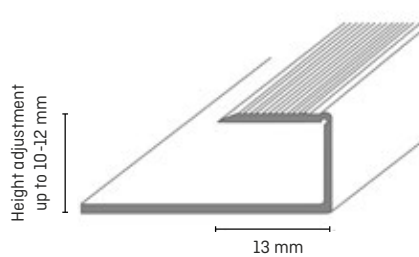

### Colours



	silver
90 cm	5101903
270 cm	5101935

# Parquet transition profile dowels

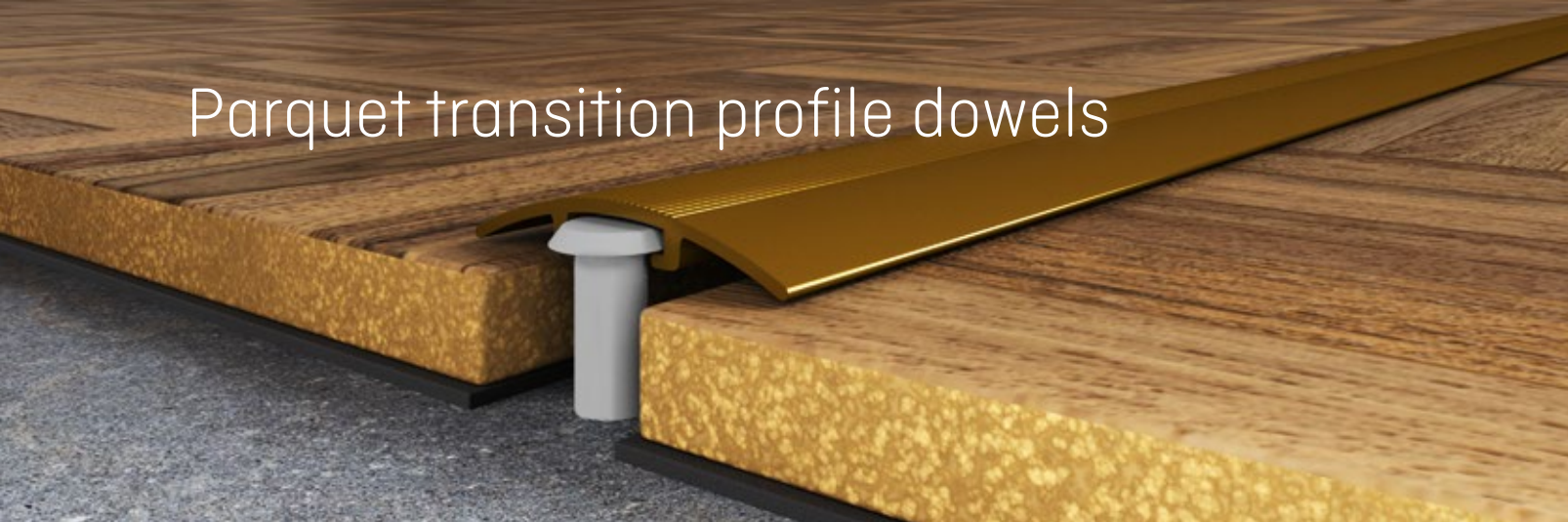

## Suitable for the following purposes

- Perfect transitions from parquet to parquet



## Product Information

- Anodized aluminum guarantees high impact and abrasion resistance
- Simple assembly with drive-in dowels
- Drive-in dowels are included
- Excellent color stability

## Available in the following dimensions:

- 1 unit = 10 x 100 cm
- 1 unit = 5 x 250 cm

## Colours

			
	silver	messing	bronze
90 cm	5120027	5120028	5101983
250 cm	5120020	5120021	-

## Accessories

for hammer-in dowels:

- 1 PU = 10 x 12 pieces
- for profile lengths of 2.5 and 2.7 m

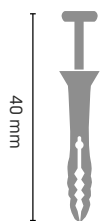

Item no.: 5103239

## Installation recommendations



Drive-in  
dowels



Elongation  
note the  
joints

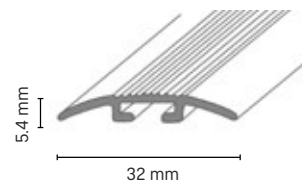

# Dowel compensation profiles



## Suitable for the following purposes

- Give parquet and laminate floors a high-quality finish with invisible fastening

## Product Information

- Compensation rails made of anodized aluminum
- High level of crush resistance
- Simple assembly with drive-in dowels

## Installation recommendations



Drive-in dowels



Elongation  
note the  
joints

## Available in the following dimensions:

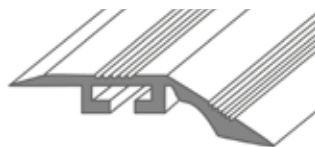

40 mm

- 1 unit = 10 x 90 cm
- 1 unit = 5 x 250 cm

## Colours



silver  
5120025  
5120019



messing  
5120026  
-



bronze  
5101966  
-

90 cm  
250 cm

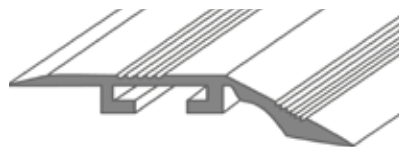

58 mm

- 1 unit = 10 x 90 cm

## Colours



silver  
5101950  
-



messing  
5101951  
-

## Accessories for hammer-in dowels:

- 1 PU = 10 x 12 pieces
- for profile lengths of 2.5 and 2.7 m

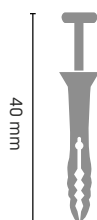

Item no. : 5103239



# Clip profiles



Processed in just 38 minutes

## Precise fitting thanks to the clip system

The clip profiles are characterized by the following properties and advantages:

- Accurate, comfortable installation guaranteed
- Simple, precisely fitting assembly thanks to a sophisticated two-part fastening system
- Convincing optics and enormous stability
- Removable for later renovation
- Transitions from 6.5 to 22mm possible

### Overview of the clip profiles

	Page
Clip profile transition .....	18
Clip profile compensation .....	19
Clip profiles completion .....	20
Clip stair angle .....	21

# Clip profile transition



## Suitable for the following types of flooring

- Particularly suitable for carpets, laminate and parquet

## Product Information

- For leveling, finishing, wall connection or stair angle
- Simple and precise installation thanks to the two-part clip system with a stable plastic lower profile
- Plastic sub-profiles are available in two heights
- The profiles can then be easily removed again for renovation, for example
- Sturdy, anodized aluminum, self-service package
- Support profile available separately
- Including screws and dowels

## Installation recommendations

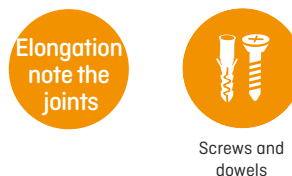
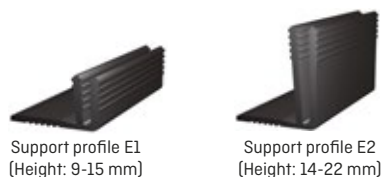

## Available in the following dimensions:

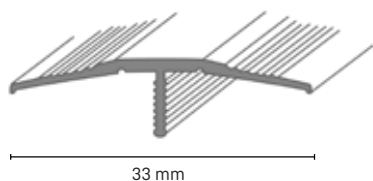

- 1 unit = 10 x 100 cm

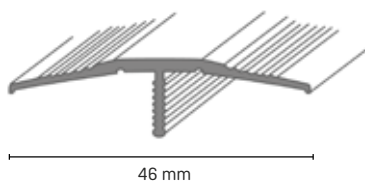

- 1 unit = 10 x 100 cm

## Colours

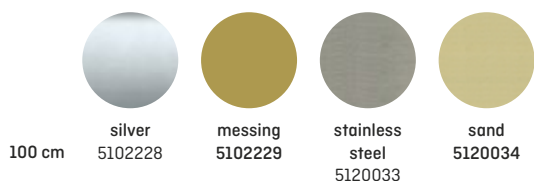

## Colours



## Accessories support profile E1 and E2

- High performance plastic
- Easy to screw into the ground
  - Easily removable again
  - Width: 22mm
  - 1 unit: 10 x 100 cm

Support profile E1  
100 cm: 5102204

Support profile E2  
100 cm: 5102205

# Clip profile compensation



## Suitable for the following types of flooring

- Particularly suitable for carpets, laminate and parquet

## Product Information

- Simple and precise assembly thanks to the two-part Clip system with stable plastic lower profile
- Plastic sub-profiles are available in two heights
- Later the profiles are for a renovation, for example easily removable again
- Sturdy, anodized aluminum
- SB-pack
- Support profile available separately
- 100 cm variant including screws and dowels

## Installation recommendations



Support profile E1  
(Height: 9-15 mm)



Support profile E2  
(Height: 14-22 mm)



Elongation  
note  
the joints



Screws and  
dowels

## Available in the following dimensions:

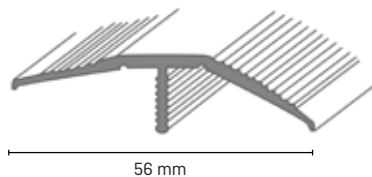

- 1 unit = 10 x 100 cm

## Colours



silver  
5102213



messing  
5102214

## Accessories

support profile E1 and E2

- High performance plastic
- Easy to screw into the ground
- Easily removable again
- Width: 22mm
- 1 unit: 10 x 100 cm

Support profile E1  
100 cm: 5102204

Support profile E2  
100 cm: 5102205

# Clip profiles completion



## Suitable for the following types of flooring

- Particularly suitable for carpets, laminate and parquet

## Product Information

- Simple and precise assembly thanks to the two-part Clip system with stable plastic lower profile
- Plastic sub-profiles are available in two heights
- Later the profiles are for a renovation, for example easily removable again
- Sturdy, anodized aluminum
- SB-pack
- Support profile available separately
- 100 cm variant including screws and dowels

## Installation recommendations



Support profile E1  
(Height: 9-15 mm)



Support profile E2  
(Height: 14-22 mm)



Screws and  
dowels

## Available in the following dimensions:

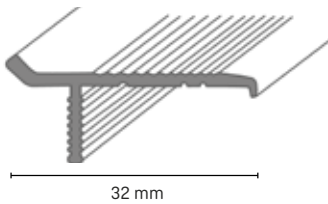

- 1 unit = 10 x 100 cm

## Colours



silver

100 cm 5102206

## Accessories

support profile E1 and E2

- High performance plastic
- Easy to screw into the ground
- Easily removable again
- Width: 22mm
- 1 unit: 10 x 100 cm

Support profile E1  
100 cm: 5102204

Support profile E2  
100 cm: 5102205

# Clip stair angle

Desired kink for adjustment to the height of the flooring with millimeter precision



## Suitable for the following types of flooring

- Particularly suitable for carpets, laminate and parquet

## Product Information

- Simple and precise assembly thanks to the two-part Clip system with stable plastic lower profile
- Plastic sub-profiles are available in two heights
- Later the profiles are for a renovation, for example easily removable again
- Sturdy, anodized aluminum
- SB-pack
- Support profile available separately
- 100 cm variant including screws and dowels

## Installation recommendations



Support profile E1  
(Height: 9-15 mm)



Support profile E2  
(Height: 14-22 mm)

Elongation  
note the  
joints



Screws and  
dowels

## Available in the following dimensions:

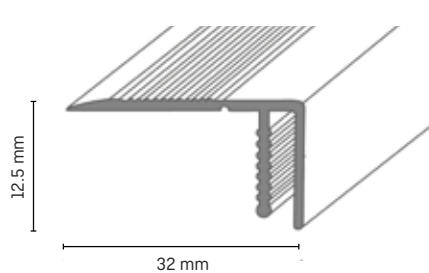

- 1 unit = 10 x 100 cm

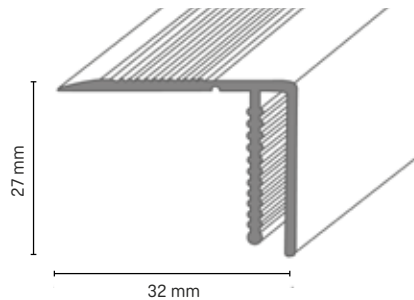

- 1 unit = 10 x 100 cm

## Colours



silver  
5102234

## Colours



silver  
5102230

## Accessories

support profile E1 and E2

- High performance plastic
- Easy to screw into the ground
- Easily removable again
- Width: 22mm
- 1 unit: 10 x 100 cm

Support profile E1  
100 cm: 5102204

Support profile E2  
100 cm: 5102205

# Professional rails



Processed in just 38 minutes

## Reliable and robust

The professional rails are characterized by the following properties and advantages:

- Reliable protection against corrosion through hard-wearing, anodized aluminum
- Very robust thanks to the extremely hard, scratch-resistant surface
- Convincing optics and enormous stability
- Simple, precisely fitting assembly thanks to a sophisticated two-part fastening system

### Overview of the professional rails

Page

Transition profile Premium .....	23
Compensation profile Premium .....	23
Graduation profile Premium .....	24



Please note that the decor images and colors do not always correspond one hundred percent to the real decor and that there may be color deviations. If you would like to have a binding decor in advance, simply request a sample via the hotline +49 2383 910 00 717 (contact person for hardware stores) or +49 3643 4170 711 (contact person for wholesalers and specialist stores)!

# Transition profile Premium

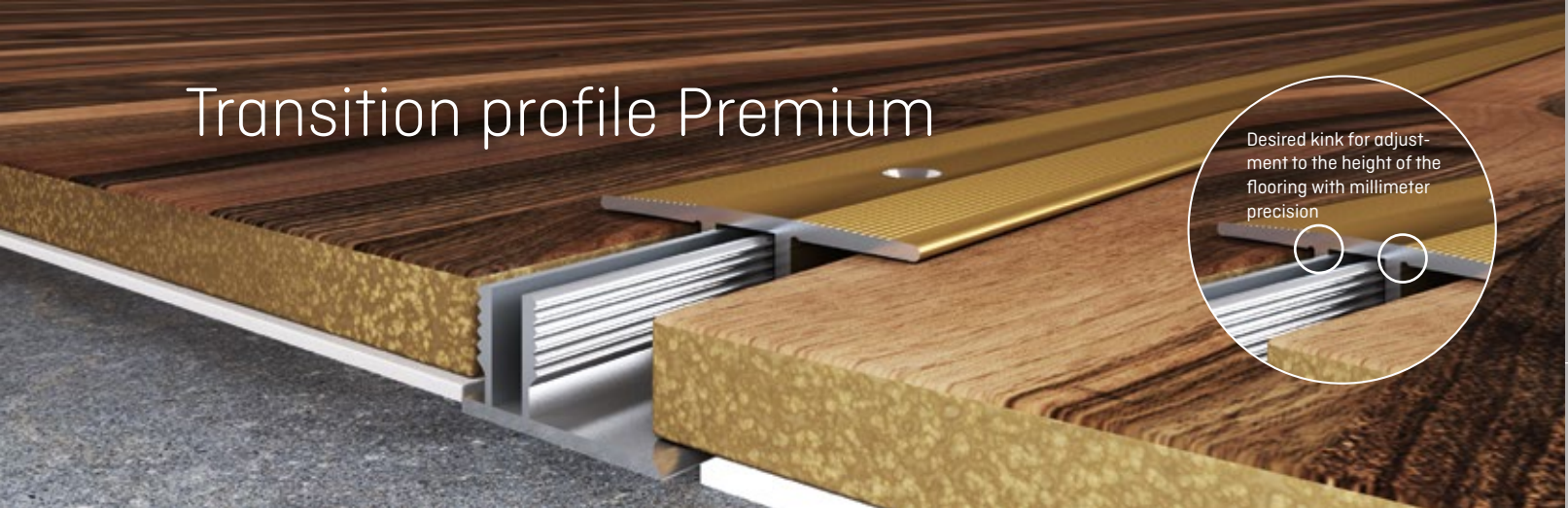

## Suitable for the following purposes

- Clean transitions between parquet or laminate floors

## Product Information

- Sturdy, anodized aluminum
- Transition rails not only protect the floor covering edges, they also cover unclean edges
- Cover profiles are simply opened with countersunk screws . screwed to the base profile
- An expansion joint must be taken into account when laying the parquet or laminate floor
- Including lower profile, screws and dowels

## Available in the following dimensions:

- 1 unit = 5 x 90 cm
- 1 unit = 1 x 270 cm

## Installation recommendations



Screws and dowels

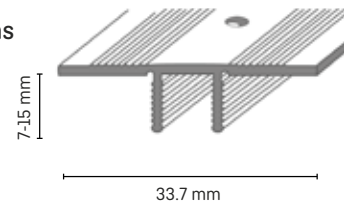

## Colours



90 cm  
270 cm

silver  
5102271  
5102280



messaging  
5102275  
5102282



sand  
5102269



bronze  
5102277



stainless  
steel  
5102273  
5102281

# Compensation profile Premium



## Suitable for the following purposes

- Clean transitions from parquet and laminate floors with a thickness of 7-15 mm to lower adjacent floors or floor coverings such as B. Carpet or PVC

## Product Information

- Sturdy, anodized aluminum
- Flexible legs of the profile strip are screwed on . . . . . of the cover profile on the base profile automatically on the required height of the adjacent covering drawn
- Including lower profile, screws and dowels

## Available in the following dimensions:

- 1 unit = 5 x 90 cm
- 1 unit = 1 x 270 cm

## Installation recommendations



Screws and dowels

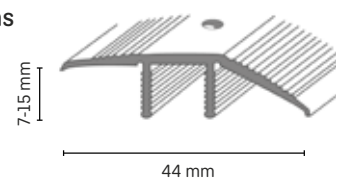

## Colours



90 cm  
270 cm

silver  
5102241  
5102250



messaging  
5102245  
5102252



sand  
5102239



bronze  
5102247



stainless  
steel  
5102243  
5102251

# Graduation profile Premium

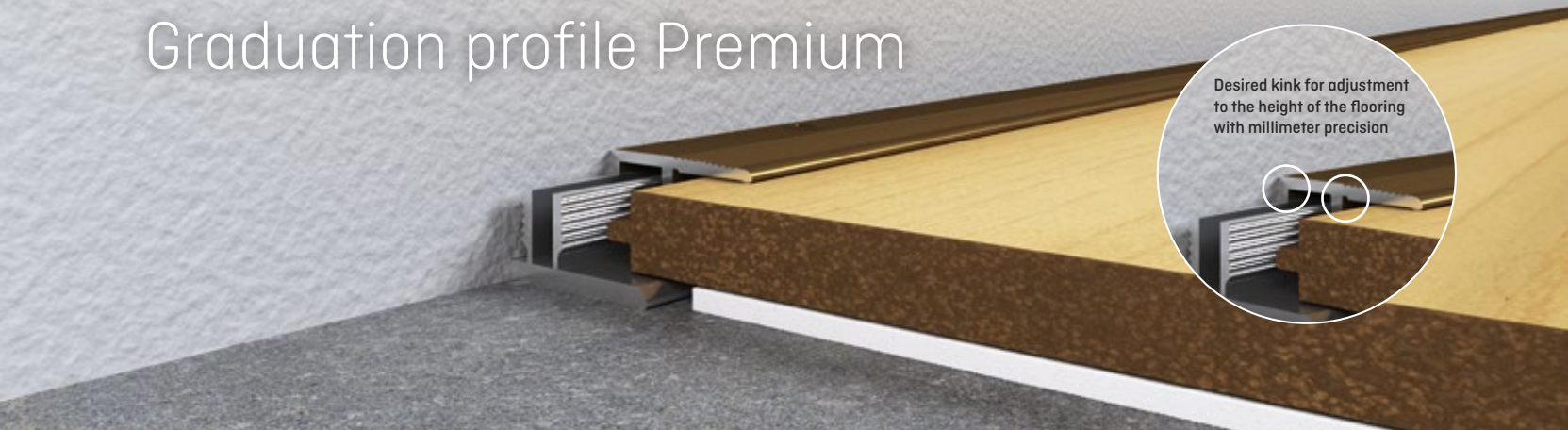

## Suitable for the following purposes

- Clean finishes for parquet or laminate floors from 7–15 mm thickness on thresholds, tiles, tiles, terrace doors and windows or other higher floors

## Product Information

- Sturdy anodized aluminum
- The pre-drilled holes make cover profiles easy attached to the base profile with countersunk screws
- Unclean edges are covered
- Including lower profile, screws and dowels

## Available in the following dimensions:

- 1 unit = 5 x 90 cm
- 1 unit = 1 x 270 cm

## Installation recommendations



Screws and  
dowels

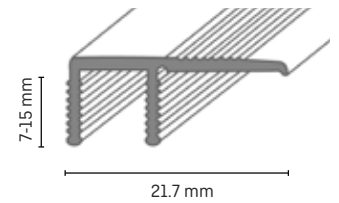

## Colours



silver  
5102256  
5102265



messing  
5102260  
5102267



sand  
5102254  
-



bronze  
5102262  
-



stainless  
steel  
5102258  
5102266

90 cm  
270 cm



# Expert design profiles



Processed in just 38 minutes

## High quality profile system for designer flooring

The Expert Design profiles are characterized by the following properties and advantages:

- Accurate, comfortable installation guaranteed
- Simple, precisely fitting assembly thanks to a sophisticated two-part fastening system
- High quality optics and enormous stability
- Especially suitable for design coverings from 4 to 7.5 mm

### Overview of the expert design profiles

	Page
Expert design transition profiles .....	26
Expert design compensation profiles .....	26
Expert design finishing profiles .....	27

# Expert design Transition profiles



## Suitable for the following types of flooring

- Especially for design and vinyl flooring from 4-7.5 mm is suitable

## Product Information

- Sturdy, anodized aluminum
- High quality optics
- Including screws and dowels

## Available in the following dimensions:

- 1 unit = 1 x 90 cm
- 1 PU = 1 x 250 cm (only for the stainless steel and silver decors)

## Installation recommendations



Screws and  
dowels

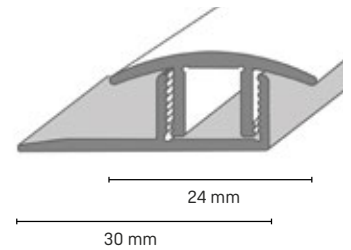

## Colours



silver  
5119857  
5119869

90 cm  
250 cm



stainless  
steel  
5119858  
5119870



sand  
5119859  
-



messing  
5119860  
-

# Expert design compensation profiles

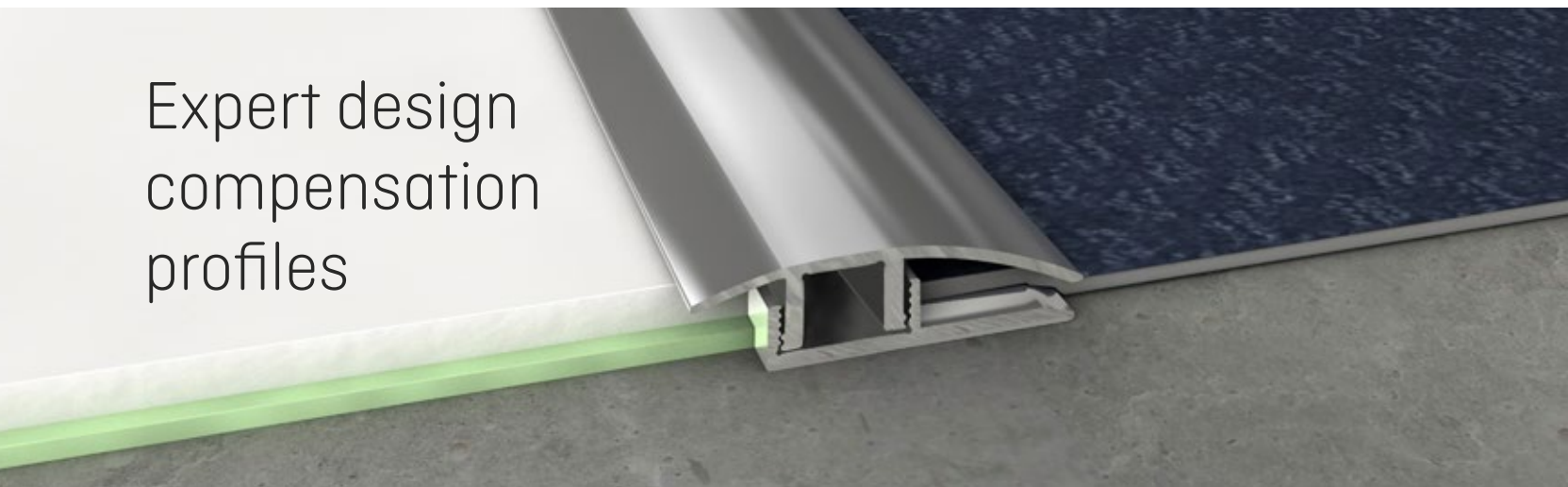

## Suitable for the following types of flooring

- Especially for design and vinyl flooring from 4-7.5 mm is suitable

## Product Information

- Sturdy, anodized aluminum
- High quality optics
- Including screws and dowels

## Available in the following dimensions:

- 1 unit = 1 x 90 cm
- 1 PU = 1 x 250 cm (only for the stainless steel and silver decors)

## Installation recommendation



Screws and  
dowels\*

\* can be reorde-  
red individually

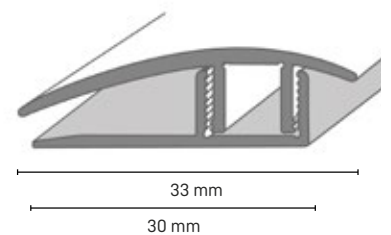

## Colours



silver  
5119861  
5119871

90 cm  
250 cm



stainless  
steel  
5119862  
5119872



sand  
5119863  
-



messing  
5119864  
-

# Expert design Finishing profiles

## Suitable for the following types of flooring

- Especially for design and vinyl flooring from 4-7.5 mm is suitable

## Product Information

- Sturdy, anodized aluminum
- High quality optics
- Including screws and dowels

## Available in the following dimensions:

- 1 unit = 1 x 90 cm
- 1 PU = 1 x 250 cm (only for the stainless steel and silver decors)

## Installation recommendations



Screws and  
dowels

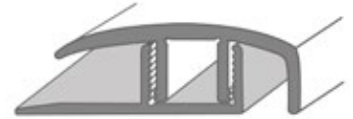

20 mm  
30 mm

## Colours



silver  
5119866  
5119873

90 cm  
250 cm



stainless  
steel  
5119867  
5119874



sand  
5119868  
-



messing  
5119865  
-

# Plastic profiles



Processed in just 13 minutes

## Flexible covering of cut edges

**The plastic profiles are characterized by the following properties and advantages:**

Optimal coverage of unclean cut edges and permanently protected transition from floor coverings

Easy assembly without professional tools

Especially suitable for PVC and carpeted floors

### Overview of the plastic profiles

Page

Cover strip .....	29
Plastic transition rail .....	29
Edging strip simple .....	30
Edging strip double .....	30

# Cover strip

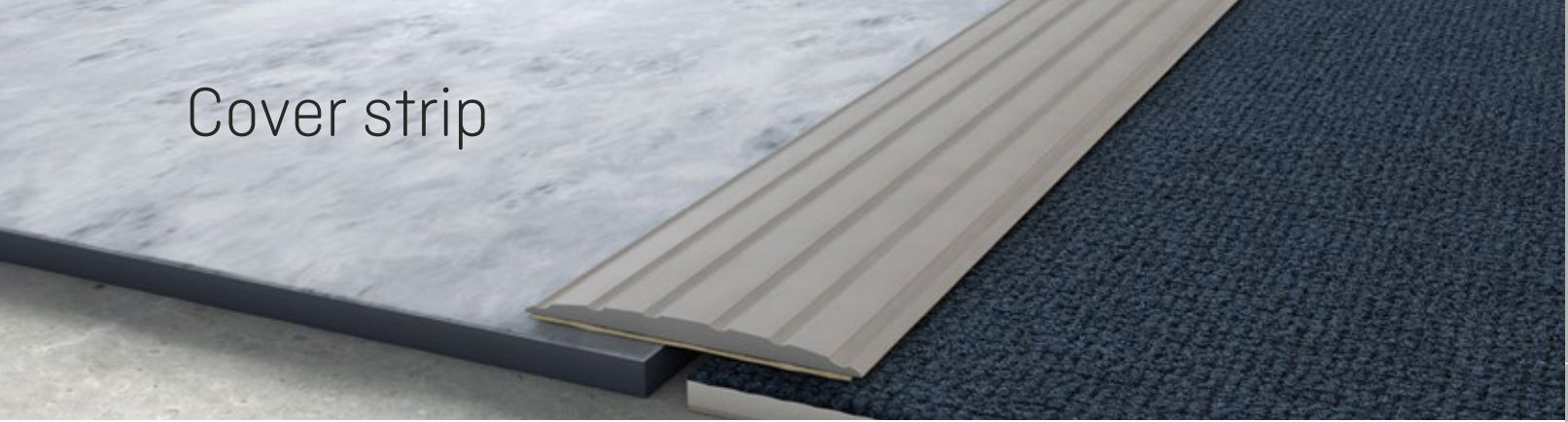

## Suitable for the following types of flooring

- Flexible adaptation through elastic soft lip to PVC and carpets with a material thickness of 3-5 mm

## Product Information

- Cover of unclean cut edges
- Can be cut to size with a carpet knife or suitable scissors
- Easy to lay without tools thanks to the self-adhesive coating on the underside
- Elastic plastic
- Self adhering
- SB-packed with assembly instructions

## Available in the following dimensions:

- 1 unit = 10 x 100 cm

## Installation recommendations

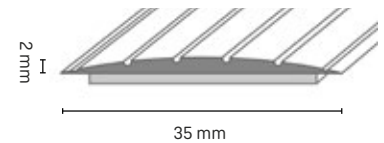

## Colours



brown  
5103431



Brown beige  
5103426



gray  
5103429

# Plastic transition rail



## Suitable for the following types of flooring

- Suitable for a wide variety of floor coverings

## Product Information

- Robust transition strip made of hard plastic
- Cut with a fine toothed saw
- Easy to assemble with the screws and dowels supplied
- Concealment of unclean cut edges of the floor coverings and permanent protection of the transition
- Flexibility in design due to the wide variety of colors
- SB-packed with assembly instructions
- Including color-coordinated screws and dowels

## Available in the following dimensions:

- 1 unit = 10 x 100 cm

## Installation recommendations



Screws and  
dowels

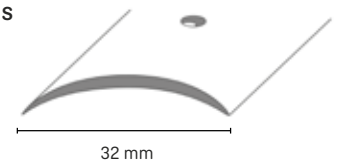

## Colours



white  
5103472



messaging  
5103480



Brown beige  
5103473



brown  
5123921



gray  
5123920



gray-beige  
5124031



black  
5123919

# Edging strip simple



## Suitable for the following types of flooring

- PVC and carpeting with one material thickness . . . . from 3–5 mm

## Product Information

- Flexible adjustment thanks to elastic soft lips
- Cover of unclean cut edges
- Elastic plastic - child's play with a carpet knife or suitable scissors
- Easy to lay without tools by selbpcs.lebebeschichtung on the bottom
- Self adhering
- SB-packed with assembly instructions

## Available in the following dimensions:

- 1 unit = 10 x 100 cm

## Installation recommendations

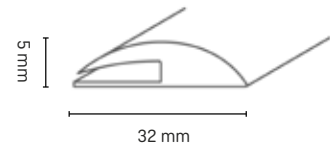

## Colours

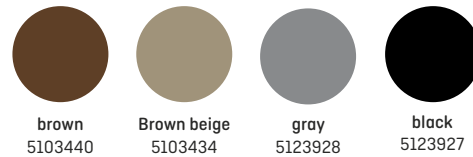

# Edging strip double

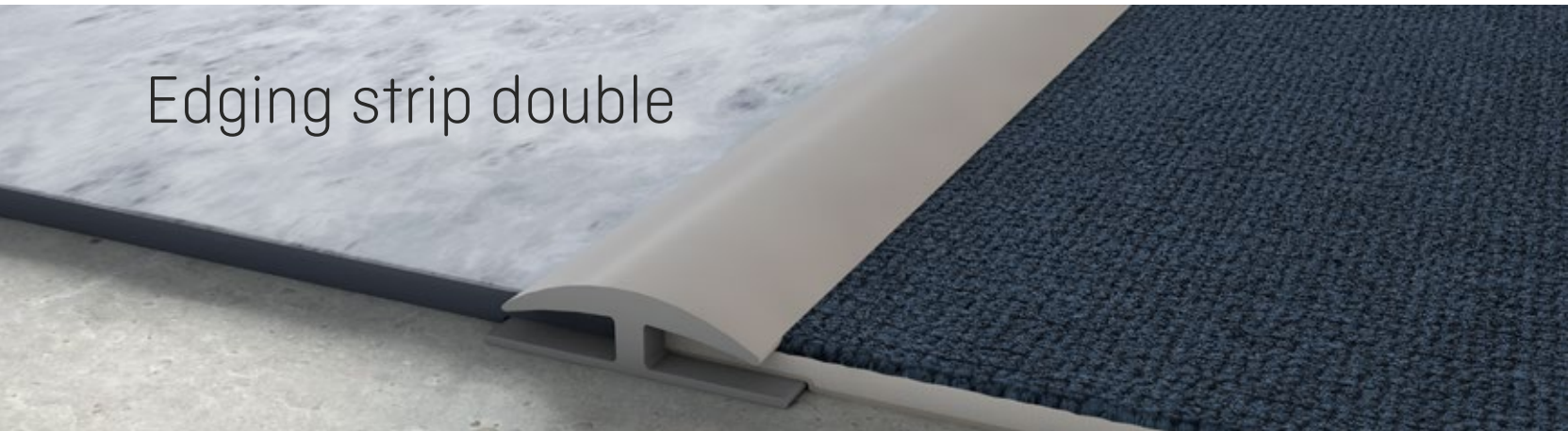

## Suitable for the following types of flooring

- PVC and carpeting with one material thickness from 3–5 mm

## Product Information

- Flexible adjustment thanks to elastic soft lips
- Cover of unclean cut edges
- Elastic plastic - child's play with a carpet knife or suitable scissors
- Easy to lay without tools by selbpcs.lebebeschichtung on the bottom
- Elastic plastic
- Self adhering
- SB-packed with assembly instructions

## Available in the following dimensions:

- 1 unit = 10 x 100 cm

## Installation recommendations

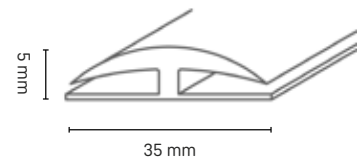

## Colours

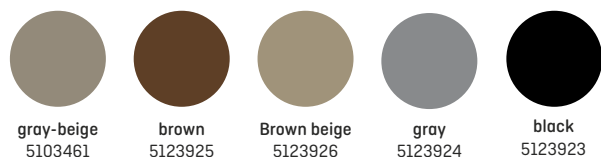

# Do you already know our new TKNNG stair nosing?

The new generation of stair nosing "TKNNG" made of plastic (polyblend based on PVC, ingredients are REACH-compliant) convince with the following advantages:

- ✓ With structured tread, slim design
- ✓ anti-slip thanks to the structured step surface  
(according to DIN 51130: 2014 - slip resistance class R10)
- ✓ standard phosphorescent / luminescent Edge for more safety in the dark
- ✓ available in 6 standard colors (special colors on request)
- ✓ also available as a self-adhesive version! \*



Our stair nosings are phthalate-free and therefore harmless to health for carefree use in suitable for sensitive environments or living spaces.

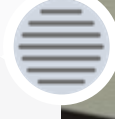

For further information, please request our main catalog or visit us online at [www.doellken-weimar.de/en/products/floor-and-special-profiles!](http://www.doellken-weimar.de/en/products/floor-and-special-profiles!)

**NOW NEW:**  
Also available as a  
self-adhesive version! \*

\* except: TKNNG A 45, TKNNG 2.5 40 and TKNNG 3.5 40

## Convincing advantages:

- ✓ easy, quick & clean
- ✓ 3 - 5 times faster assembly
- ✓ solvent-free bonding
- ✓ strong adhesion with the Remur-Branded adhesive tape from UZIN
- ✓ exchangeable at any time
- ✓ no laying & glue pre-painting necessary

